

49 30 6190880
 49 30 6190880
 49 30 6190880
 49 30 6190880

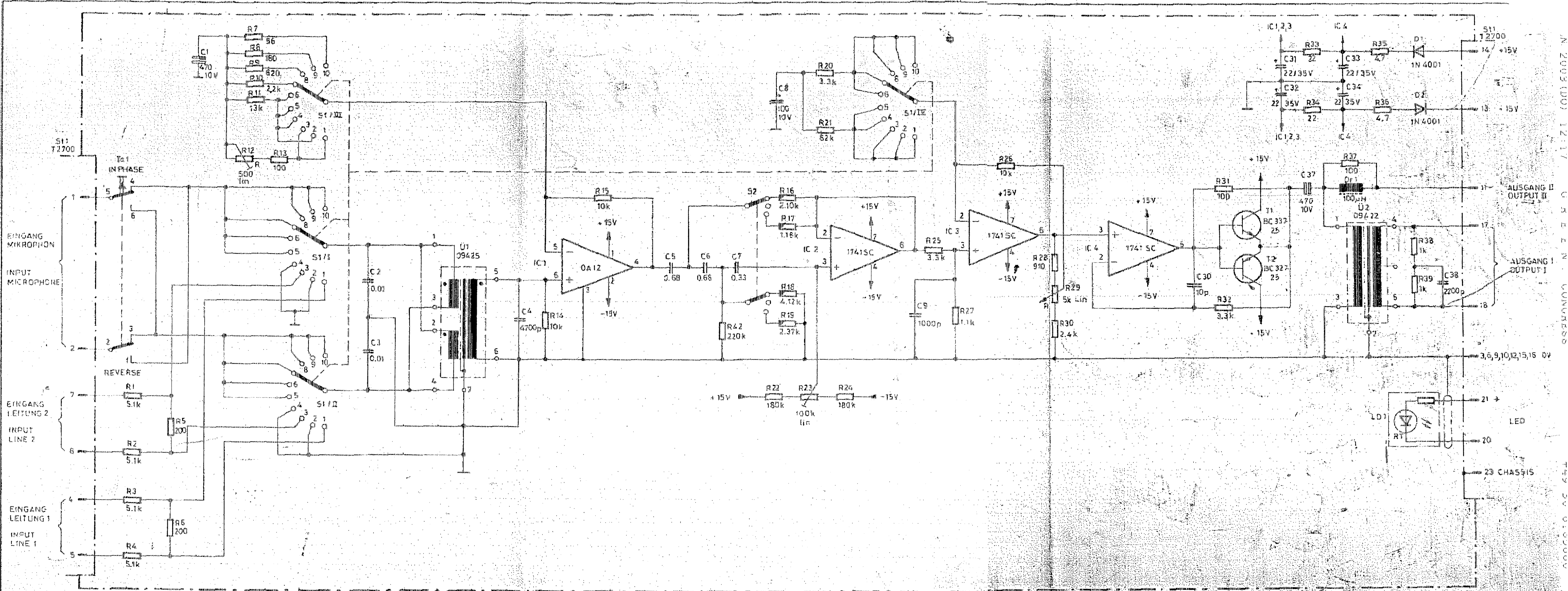

BEI ERSATZTEILBESTELLUNG BITTE GERÄT-NR.
 U. POS.-ZAHLEN ANGEBEN!
 FOR REPLACEMENT PLEASE ALWAYS GIVE
 SERIAL & PART NO!
 GÜLTIG AB GERÄT NR. 021
 BEGINNING WITH SERIAL NO. 021

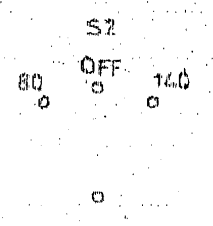
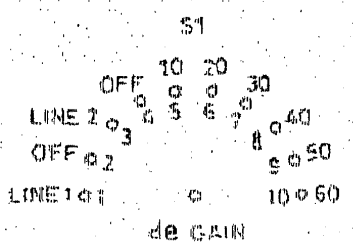
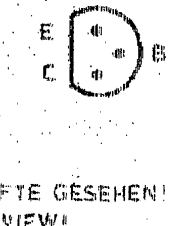
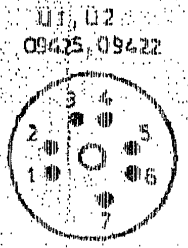
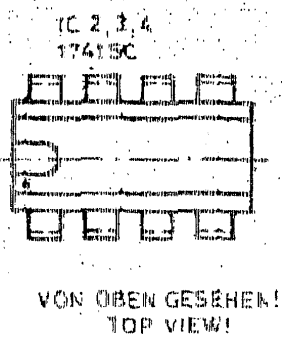
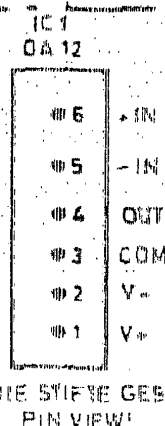
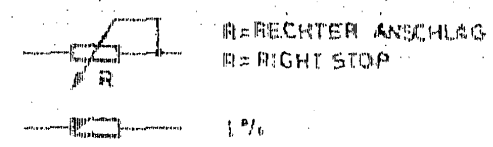

AUF DIE MESSER GEGEHEN! PIN VIEW!

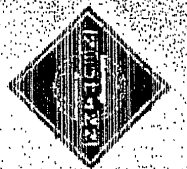

MIKROPHONVERSTÄRKER OV 60
MICROPHONE PREAMPLIFIER OV 60
 3 1752-930-800 01
GEORG NEUMANN GMBH
BERLIN
 8535300071 3

N 2003 (D0) 12.17
 C R E N
 49 30 6190880
 V-171 III 12